



user instructions and warranty

**airflo**  
(battery version)

freedom

through lightweight solutions

# UK

The Airflo by Mangar International, is a low pressure air compressor, which has been designed for use with Mangar International pneumatic lifting equipment.



PLEASE BE SURE THAT YOU HAVE READ AND UNDERSTOOD THESE INSTRUCTIONS AND THOSE PROVIDED WITH ANY OTHER MANGAR INTERNATIONAL PRODUCT, BEFORE OPERATING THE EQUIPMENT.

## CONTENTS

Standard Package Contents	Pg 3
Battery Gauge	Pg 3
Battery Charging	Pg 4
Connecting the Air Hose	Pg 4
Extra Air Flow	Pg 5
Different ways to operate the Airflo	Pg 5
Cleaning & Storage	Pg 8
Maintenance	Pg 8
Trouble shooting guide	Pg 9
Specifications	Pg 9
Symbols used on Airflo and Charger	Pg 10
Symbols used on packaging	Pg 11
Warranty	Pg 11



## WARNINGS

- **DO NOT** place the battery charger in a bathroom or in a damp environment.
- **ALWAYS** disconnect from the battery charger before cleaning.
- **USE ONLY** the supplied battery charger.
- **NOT SUITABLE** for use in the presence of flammable anaesthetic mixtures with air, oxygen or nitrous oxide.

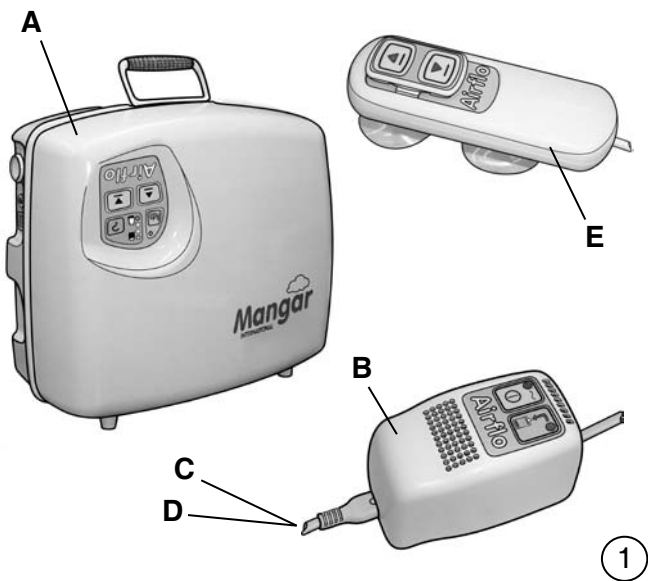



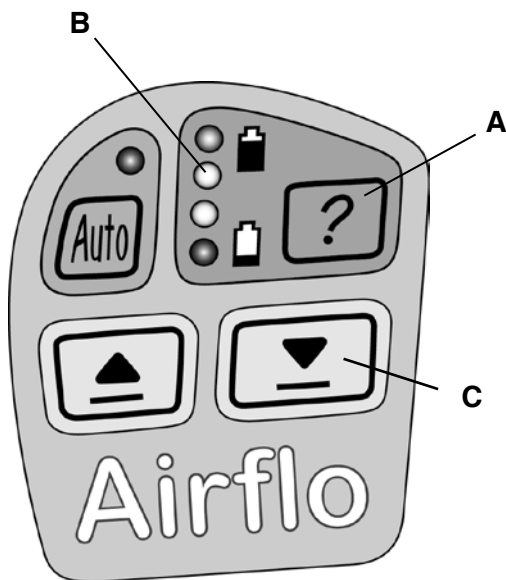

**Standard Package Contents - fig. ①**

- 1 x Airflo compressor fitted with two 12v - 2.3Ah batteries (A)
- 1 x Battery charger (B)
- 1 x UK mains charger lead (C)
- 1 x Euro mains charger lead (D)
- 1 x Push-button hand control (E)
- 1 x User instructions



**Battery Gauge - fig. ②**

Before use, check that the batteries are sufficiently charged. Ensure that the battery charger is not connected to the Airflo and then press the battery indicator button (A) to activate the indicator lights (B). If the batteries are fully charged, all four indicator lights will flash.

-  = (Green) fully charged
-  = (Yellow) partially discharged
-  = (Yellow) recharge soon
-  = (Red) recharge immediately (will not deflate)

NOTE: If charge is too low the 'down' button (C) will not work.

② The Airflo needs to be recharged when the lower of the two Yellow indicator lights is lit (see "Battery Charging").

**Charge the batteries overnight before first using the Airflo.**

# UK

## Battery Charging - fig. ③

- Connect the battery charger output lead (**A**) to the Airflo charging socket (**B**) and the mains lead (**C**) to a mains power socket, the mains light (**D**) will glow.
- The charging light (**E**) will glow while the batteries are charging and go out when they are sufficiently charged. The light may flash when the batteries approach fully charged.

If convenient, the Airflo may remain continuously on charge when not in use as the batteries cannot be overcharged using this charger.

**WARNING:** DO NOT recharge the batteries in a bathroom or in a damp environment.

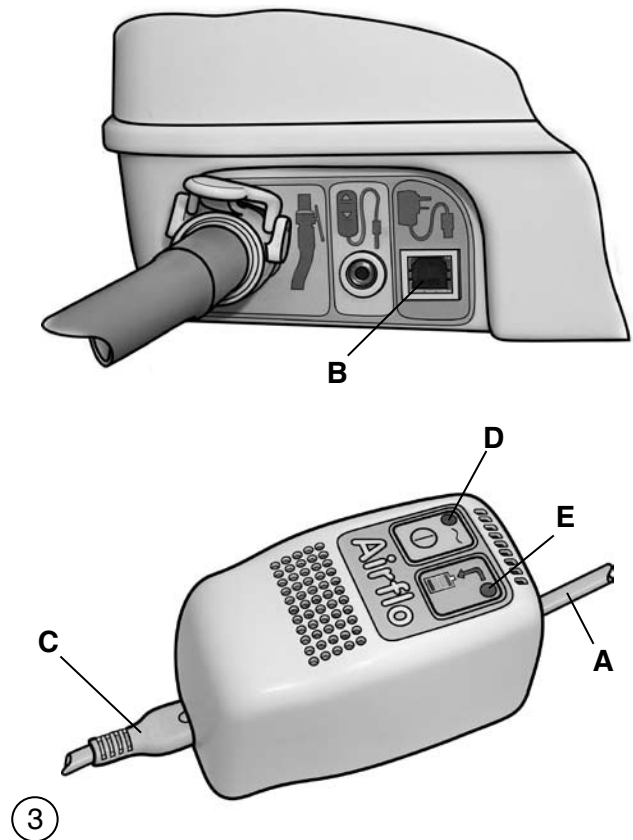

## Connecting the Air Hose - fig. ④

Disconnect the Airflo from the battery charger and place the Airflo in a safe and convenient position.

Connect the air hose from the Mangar International equipment to the air outlet socket (**A**). The connector will 'click' into place when firmly pushed onto the outlet. To release the hose, press the paddle down on the connector.

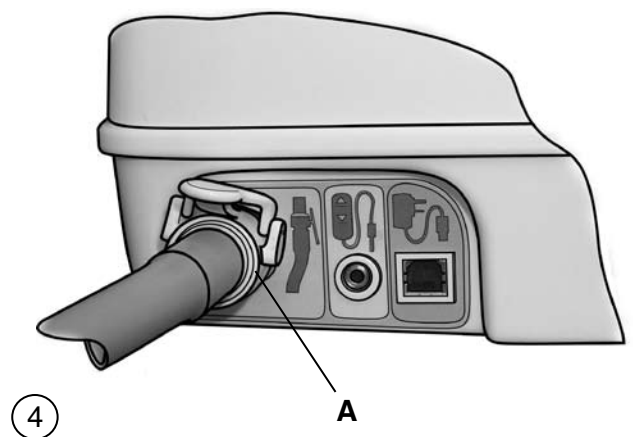

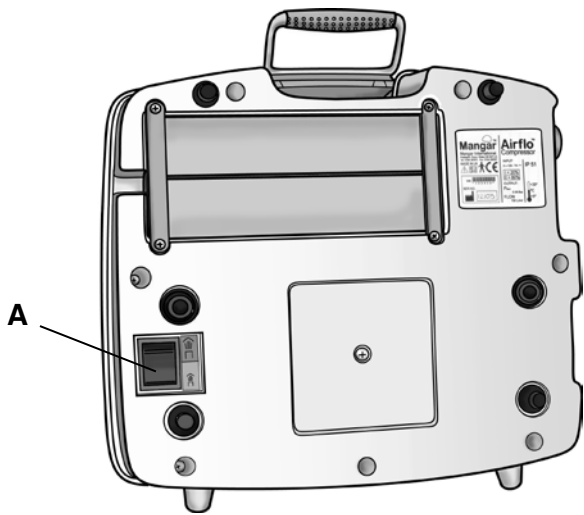

5

**Extra Air Flow - fig. 5**

The switch (A) on the underside of the Airflo changes the air flow from 'Normal' to 'High'. The switch should usually be set to 'Normal' and only changed to 'High' when directed to do so by the user instructions for the Mangar International product that is to be inflated. The 'High' setting allows for faster inflation of the larger Mangar International products such as the Mangar Wedge, Mangar Handy Bather and Mangar CAMEL.

- Press the switch to change between 'Normal' and 'High' air flow.

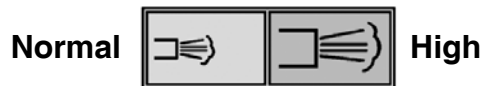

**WARNING:** DO NOT operate the Normal/High air flow switch while the compressor is running.

**Different ways to operate the Airflo**

**Built-in Control Buttons - fig. 6**

These are located within the recessed 'Airflo' label on top of the compressor.

- Press the 'Up'  button to raise.
- Press the 'Down'  button to lower.

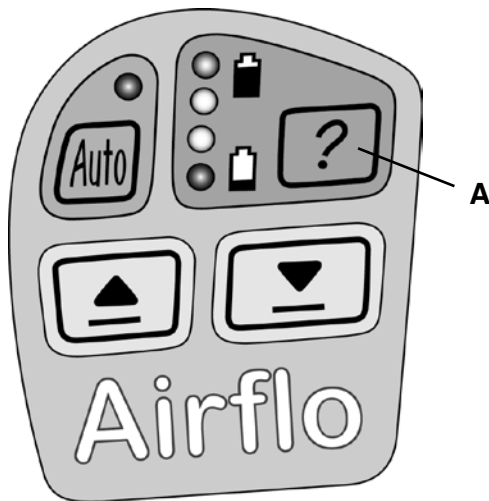

6

The 'Up' or 'Down' buttons can be set to operate for a preset duration of 60 seconds. This function is particularly useful when inflating the larger Mangar International products such as the Therapy Wedge or when deflating the products without the need to keep the 'down' button pressed. To select this function:

- While pressing the 'Up' or 'Down' button momentarily press the battery indicator button (A) and then release the 'Up' or 'Down' button. The Airflo will continue inflating or deflating for 60 seconds. The function can be cancelled by pressing any button.

# UK

## 'Auto' Control Button - fig. ⑦

The 'Auto' function is designed for use with the range of Mangar International pneumatic hand controls:-

- Lever Hand Control - fig. ⑨
- CAMEL Hand Control - fig. ⑩
- ELK Hand Control - fig. ⑩

To switch on, press and hold the 'Auto' button until the light (A) comes on. The light will stay on while the 'Auto' function is selected.

Pressing any of the built-in control buttons will cancel the 'Auto' function.

When in 'Auto' mode, the internal microprocessor carries out a battery voltage check each time air is required and if the voltage becomes too low, the 'Auto' function will be cancelled automatically.

## Locking the built-in buttons - fig. ⑦



If desired, to prevent unauthorised use, the built-in buttons can be locked to prevent them from working. NOTE: The Push-Button hand control (see below) will still work when the built-in buttons are locked.

- Hold the battery indicator button (B) and then the 'deflate' button (C).
- With buttons (B) and (C) held, press the following buttons in sequence: 'Auto' (D), 'Up' (E), 'Auto' (D), 'Up' (E) - **All within 3 seconds.** Confirmation that the buttons are locked will be indicated by a double flash of all the lights.

To unlock the built-in buttons, repeat the locking procedure.

## Push-Button Hand Control - fig. ⑧

Connect the hand control (A) to the socket (B).

- Press the 'Up'  button to raise.
- Press the 'Down'  button to lower.

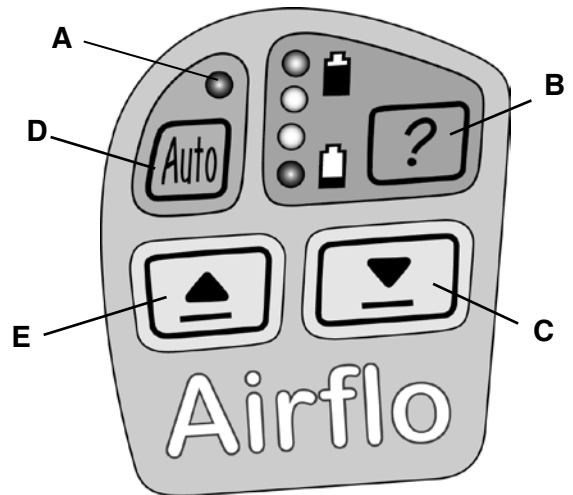

⑦

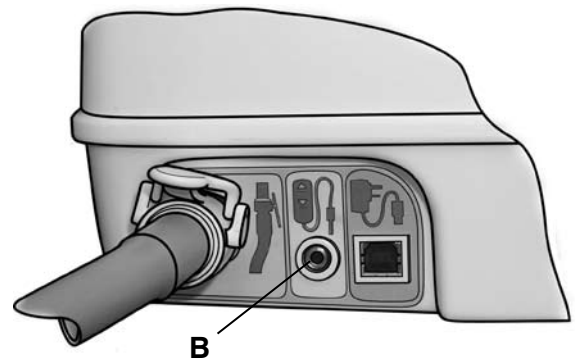
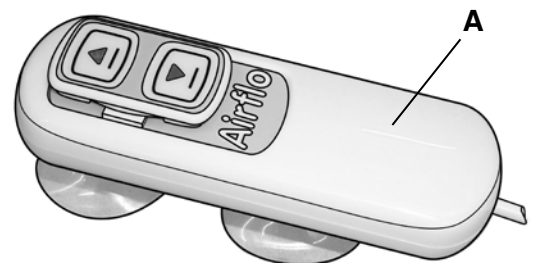

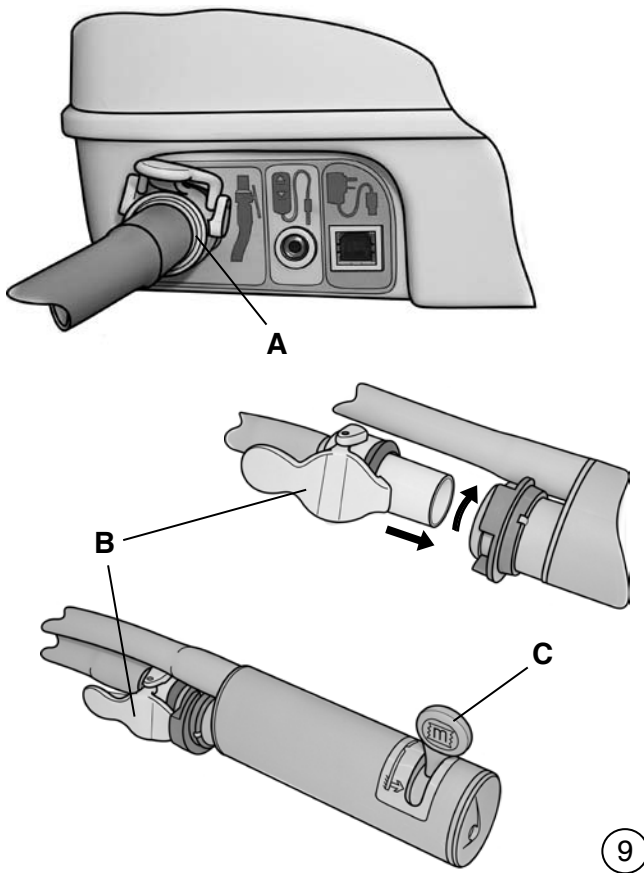

⑧

**Lever Hand Control - fig. ⑨**

When using the lever hand control, connect the air hose from the lifting aid to the hand control (B), rotating the connector to lock it in place. Connect the air hose from the hand control to the Airflo air outlet socket (A).

Select 'Auto' function (see 'Auto' Control Button).

- Move the lever (C) to 'up'  to raise.
- Move the lever to 'down'  to lower.
- Move the lever to 'neutral/stop' to stop at any height.

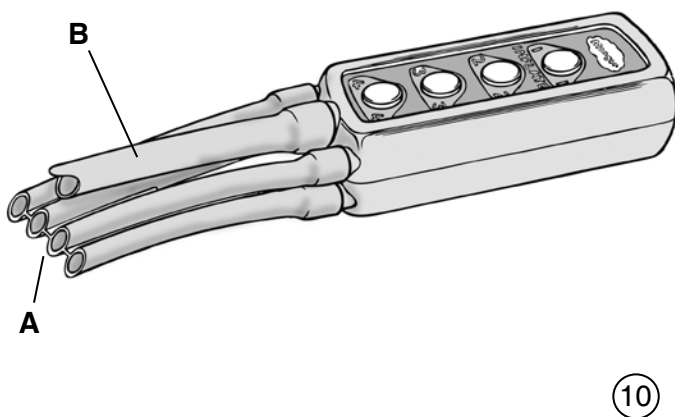
**CAMEL and ELK Hand Controls - fig. ⑩**

- Connect the four hoses (A) from the Hand Control to the corresponding numbered and coloured connectors on the Mangar International product.
- Connect the hose (B) from the Hand Control to the Airflo air outlet socket.
- Pressing any of the numbered buttons will deliver air to the corresponding numbered hose (follow the user instructions for the Mangar International product that is to be inflated).

# UK

## Cleaning

- Unplug the Airflo from the battery charger. Clean the external surfaces using a damp cloth and allow to dry thoroughly before reconnecting to the battery charger. Do not allow moisture to enter any part of the compressor.
- Do not use solvent-based products.

## Storage

- When not in use, store in a dry place together with these instructions. To maintain the batteries, when being stored for long periods, put the Airflo on charge overnight every 6 months.

## Maintenance - fig. 11

At approximately 12 month intervals, inspect the air filter located in the base of the Airflo (**A**), and if necessary, fit a new filter (a kit of replacement filters is available through your supplier - part number: CA0233).

Battery replacement:

- Turn the Airflo upside down and remove the four screws (**B**) followed by the two battery supports and rubber spacers (**C**). Turn the Airflo the right way up to remove the batteries.
- Fit the replacement batteries so that their contacts are towards the centre line of the battery compartment. **NOTE:** Be careful not to displace the battery compartment terminals when changing the batteries.

**IMPORTANT:** Always replace both batteries and use the same type.





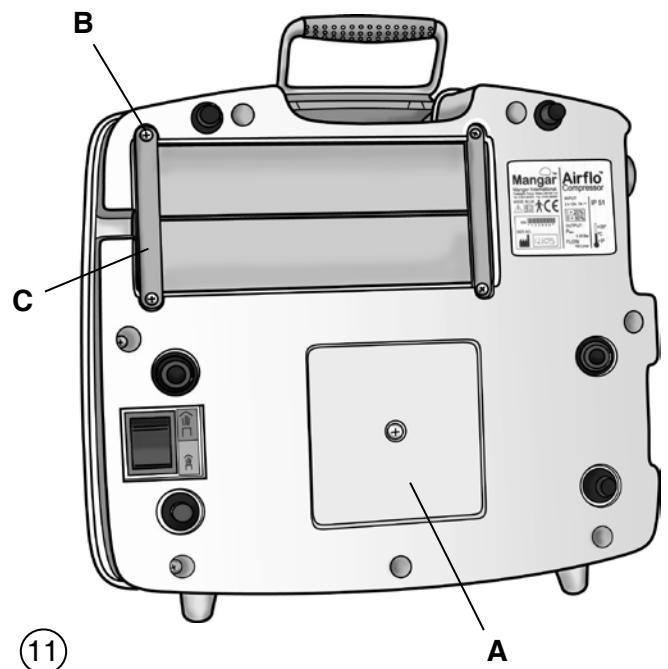











The Airflo contains no other serviceable parts. If a fault should develop, please contact your supplier for further advice.

If required, Mangar International can provide the above maintenance within an annual service contract. Please contact our Customer Service department for further details (See page 11 for further information).



11

**Trouble shooting guide**

<p> Compressor does not run when the lever hand control is moved to 'up' or CAMEL/ELK hand control buttons are pressed.</p>	<p> Compressor keeps stopping when trying to inflate the lifting aid.</p>
<p> Ensure that the 'Auto Function' has been selected.</p>	<p> Check that there are no kinks in the air hose. Check that the 'Normal/High' air flow switch is in the 'Normal' position.</p>
<p> Ensure that the built-in buttons have not been locked.</p>	<p> 'Auto' light flashing.</p>
<p> Compressor does not run when 'up' is selected on the push button hand control.</p>	<p> This happens when the compressor's internal temperature cut-out has tripped. Leave the Airflo for 15 minutes to cool.</p>
<p> Ensure that the air hose from the product being inflated is connected to the Airflo.</p>	<p> The top two lights on the Battery Gauge are flashing.</p>
<p> Check that there are no kinks in the air hose.</p>	<p> This happens when the overload cut-out has tripped. Press any button to reset.</p>
<p> Built-in buttons do not respond when pressed.</p>	<p> Compressor causes electrical interference with another piece of electrical equipment.</p>
<p> Ensure that the built-in buttons have not been locked.</p>	<p> Move either the compressor or other item further away from each other until the interference stops.</p>

**Specifications**

**Airflo**

Weight:	5.7Kg (12½ lbs)
Output pressure:	0.35 bar (5 psi)
Batteries:	2 x 12v - 2.3Ah (Valve Regulated Sealed Lead Acid)
Environmental protection:	IP51 (Airflo housing) IP67 (Push-button hand control)



recycle



do not dispose of in household waste

Type B equipment













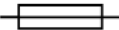
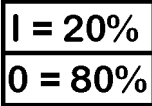
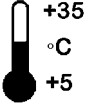

This equipment has been tested and meets the requirements of current EMC legislation

**Charger**



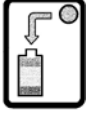



Input:	230v, 10VA
Output:	24v, 350mA
Internal protection:	3A (T) Fuse; 2A & 130°C Thermal Fuse
Environmental protection:	IP30
Double insulated Class II equipment	

# UK

## symbols used on Airflo and Charger labels

	Attention consult instructions		Class II Double Insulated equipment
	Type B equipment (protection against electric shock)		Dangerous voltage
	Alternating current (AC)		Direct current (DC)
	Fuse (with rating)		Duty cycle I = Operating time O = Non operating time
	Max/Min operating environment temperature		'Auto' select button
	'Up' button		Battery gauge button
	'Down' button		'Battery charging' indicator
	Do Not connect to mains power in a bathroom or outdoors		'Mains power connected' indicator
			Date of manufacture



symbols used on packaging	
 Keep packaging dry	 Recycle packaging
 Handle with care	 Do not dispose of in household waste
 Max/Min storage temperature	<b>90% RH</b> <b>10% RH</b> Max/Min humidity when transporting in pressurised aircraft hold
 Net & gross weights	<b>125 kPa</b> <b>73 kPa</b> Max/Min pressure when transporting in pressurised aircraft hold
 Stack no more than five high	<b>+50°C</b> <b>-10°C</b> Max/Min temperature when transporting in pressurised aircraft hold

**Warranty**

Mangar International guarantees this product for a period of two years.

The guarantee is given against defects in material and workmanship and comprises piece, parts and labour. The guarantee is not valid in the case of fair wear and tear, wilful damage, common neglect, misuse or unauthorised alteration or repair by unqualified persons.



The following statements do not affect the consumer's statutory rights. This product is sold on the understanding that in the event of any defect of manufacture or material appearing within two years of the date of receipt of this product, the defect will be rectified free of charge providing that:

- (a) Reasonable evidence is provided (e.g. purchase invoice, delivery note) that the product was not purchased more than two years prior to the date of the claim.
- (b) The defect is not attributable to accidental damage (either in transit or otherwise), misuse or unauthorised repair.

Airflo serial number: .....

Date of purchase: .....

Invoice/Delivery note number: .....



We strive to provide our customers with reliable and durable products of the highest quality. In addition to a two year guarantee, and for added peace of mind, our servicing division, Primeserve, also offers a variety of service options. Choose from an **Extended Parts Warranty**, **Call-Out Protection** and an **Annual Service and Clean**.

To find out how we can provide complete cover for your Mangar International product call our Customer Service Department on **Freephone 0800 280 0485**.

Mangar International reserves the right to alter product specifications and/or any of the information contained within this document without notice.

freedom through lightweight solutions



**Mangar International**

Presteigne

Powys

Wales, UK

LD8 2UF

tel: +44 (0)1544 267674

fax: +44 (0)1544 260287

customerservice@mangar.co.uk

www.mangarinternational.co.uk

Patents Pending

MI0214 issue 2